

Submitted Model No.: _____

Specific Features: _____

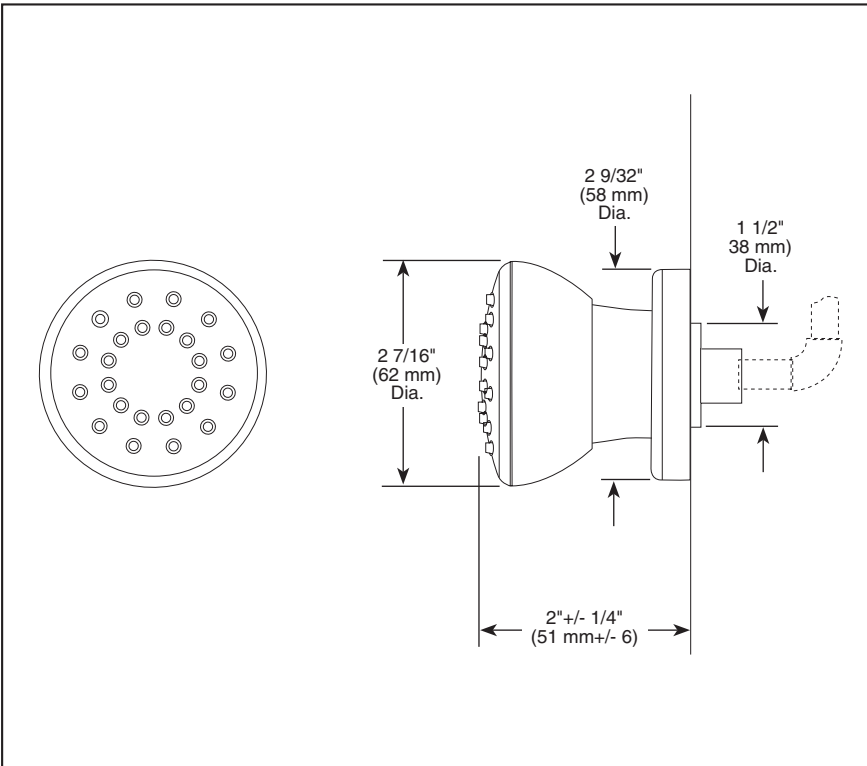

BODY SPRAY

- 2.0 GPM
- 1/2" Rough-In

STANDARD SPECIFICATIONS

- 1/2" rough-in.*
 - 30° up and down adjustment.
 - 2.0 gpm @ 80 PSI.
 - Solid brass construction.
 - Matching finish spray face.
 - Touch-clean® nubs.
- *Note: This installation requires a 1/2" male threaded pipe fitting to extend 1/4" beyond the finished surface.

WARRANTY

- Lifetime Faucet and Finish Limited Warranty to the original consumer purchaser to be free from defects in material and workmanship.
- 5 Year Limited Warranty for usage in all industrial, commercial and business applications.



COMPLIES WITH:

- ANSI/ASME A112.18.1 / CSA B125.1

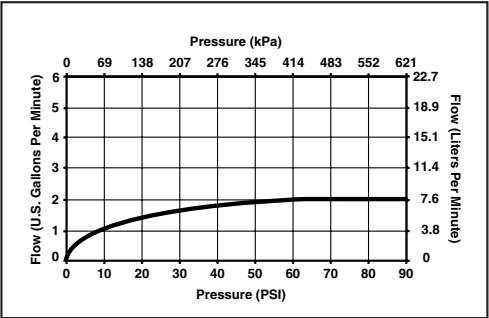

Delta reserves the right (1) to make changes in specifications and materials, and (2) to change or discontinue models, both without notice or obligation. Dimensions are for reference only. See current full-line price book or www.specselect.com for finish options and product availability.

